

UZAY
ASANSÖR



1982 yılında bu günkü ortaklık yapısına kavuşmuş olan Uzay Asansör şu ana kadar 1000'e yakın sayıda asansör montajı gerçekleştirmiştir. Şirket hali hazırda 140 m2 idari büro, 1200 m2 kapalı alana sahip fabrikaya ve kendi üretim makinalarına sahiptir. Yıllık üretim kapasitesi yeni yapılan yatırımlarla 100 adettir. 200'e yakın sayıda asansöründe periyodik bakımı gerçekleştirilmektedir. Firmamızın montaj politikası ise az sayıda fakat kaliteli montaj yapabilmek, montajını kendi yaptığı asansörler dışında kalan asansörlere mümkün olduğunca bakım yapmamaktır.

Firmamız 2000 yılında TSE'den alınan sertifika ile ISO 9001-2000 Kalite Yönetim Sistemi uygulanmaktadır. 2004 yılı Haziran ayında da Hollanda'lı LIFT INSTITUT Firmasının denetiminden geçerek hem Kalite Yönetim Sistemimizin geçerliliğini bir başka kuruma da onaylattırılmış hem de 95/16/AT yönetmeliği Ek 13 Modül H'ye göre tesis ettiğimiz asansörlere CE işareti ilaştırme hakkını almış olduk.

Üretim potföyümüzde 100-15,000Kg taşıma kapasiteli ve 0,25m/sn-3,50m/sn hız aralığında konut, işyeri, alışveriş merkezi, hastane, fabrika ve özel tesis asansörleri bulunmaktadır. Türkiye'nin her bölgesinde olduğu gibi yurt dışında da montaj ve servis hizmetlerimizle 7 gün 24 saat sizlerle çalışmak için her an hazırız.

Attaining its present partnership structure in 1982, Uzay Asansör has installed about 1,000 lifts until now. Company has a 140 m2 managerial office and a 1,200 m2 closed-area factory with its own production machineries. Annual production capacity with the new investments is 100 lifts. Maintenance work for around 200 lifts is performed periodically. Installation Policy of our Company is to make fewer installations but make it with the highest quality possible and try not to perform maintenance work to the lifts installed by other companies.

Our Company is carrying out ISO 9001-2000 Quality Management System with Certificate given by Turkish Standards Institute in 2000. In June 2004 after a detailed inspection the validity of our Quality Management System was approved by another company called LIFT INSTITUT (The Netherlands). Our Company has the right to attach the CE sign to its lifts with the regulation 95/16/AT Annex 13 Module H.

Our production portfolio contains; residential, work-place, shopping center, hospital, factory and private establishment lifts with the carrying capacity of 100-15,000Kg with the speed interval of 0,25m/sec-3,50m/sec. We are ready to work for you 7 days a week and 24 hours a day in any region in Turkey and abroad with our installation and maintenance services.

Bahadır ALTUN

Genel Müdür / General Manager





GÜVENLİK konut asansörlerinde daha da önem kazanır. Çocuklarımızın bu asansörleri kendi başlarına kullanabileceklerini düşünmek bile bu işin ne kadar önemli olduğunun bir göstergesidir.

Diğer tüm asansörlerimiz gibi konut asansörlerinde de kapı sıkışma kontakları, optik algılayıcılar ve 95/AT/16 Asansör direktifinin tüm gerekleri eksiksiz yerine getirilir





SAFETY is even more important in Residential Lifts. Considering that our children may use these lifts by themselves shows how important this matter is. Like all of our other lifts, door obstacle contacts, optic sensors and all the requirements of Lift Directive 95/AT/16 is fulfilled completely on residential lifts.





DAYANIKLILIK İşyeri Asansörlerinin vazgeçilmez unsurudur. Sabah işyerinize geldiğinizde 15 katlı bir binanın merdivenlerini çıkmak bütün iş motivasyonunuzu kaybettirebilir. Katlar arası trafiğin diğer tip asansörlerden çok daha yoğun olduğunu hatırlatırsak dayanıklılığın yanında hızın da bu tip asansörlerde vazgeçilmez bir öğe olduğu kolayca anlaşılır. Kapı ön açma ve Hız Kontrol Sistemi (VWF) bu tip asansörler için her zaman önerdiğimiz opsiyonlardır.





DURABILITY is an indispensable element of Workplace Lifts. When you come to your workplace, climbing the stairs of a building of 15 floors could make you lose your motivation in the morning. If we remind you the high intensity of the traffic between the floors, it would be easily understood that the speed is an indispensable element among durability in this type of lifts. Door pre-open and Speed Control System (VVF) are the options which we always recommend for this type of lifts.





ESTETİK bir panoramik asansör bütün kullanıcıların kendini mutlu ve güvende hissedeceği bir yer olmakla kalmayıp aynı zamanda binanın ambiyansını değiştiren bir öğedir. Panoramik asansörlerdeki tek sınırlama malzemelerin ve mekanın bizi kısıtlamasıdır. Bunun dışında size hayal etmek bize uygulamak kalıyor.



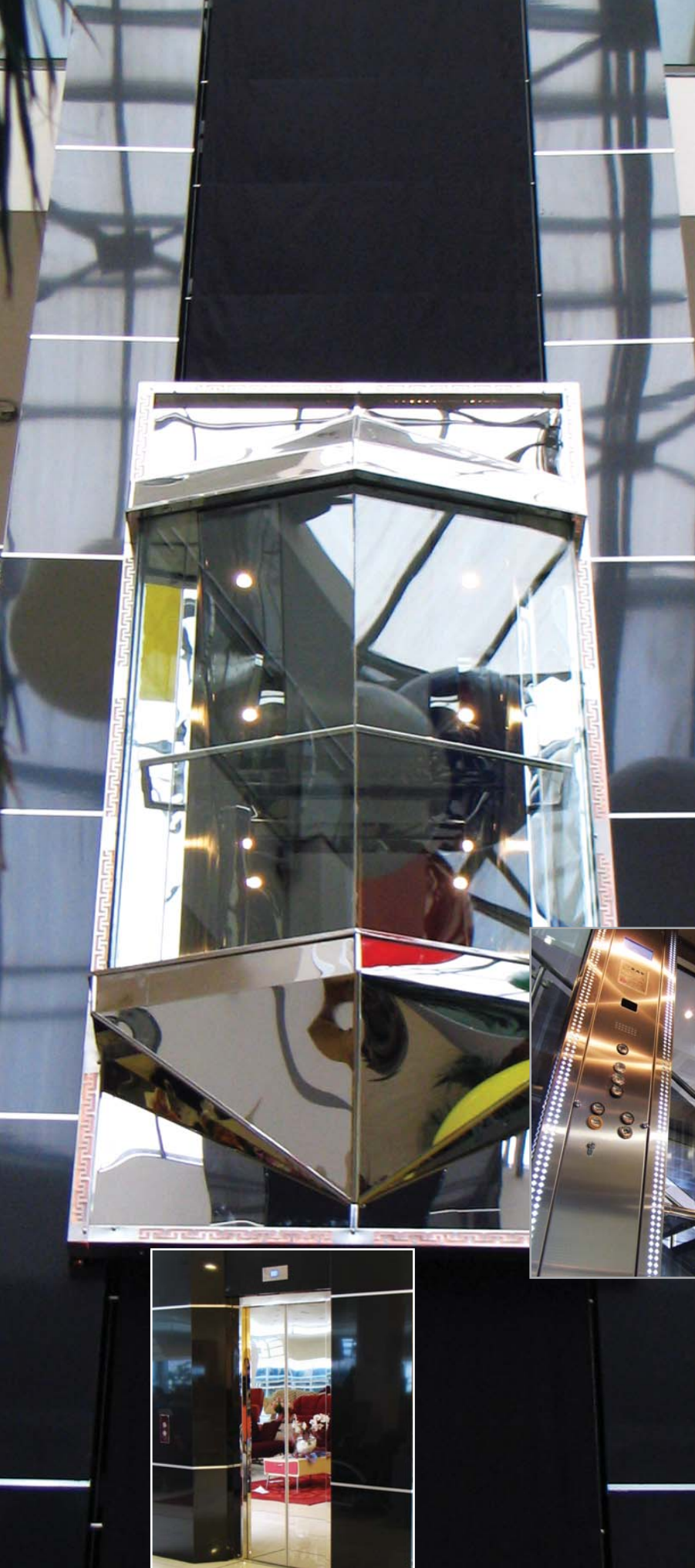

An **ESTHETIC** panoramic lift is not only a place where all the passengers feel themselves happy and safe but also an element changing the ambience of the building. The only limitation on panoramic lifts is the restriction of the equipment and spatial factors. Other than that, you need to imagine and we need to apply.





HASSASİYET olmadan çalışan bir asansörü düşünün. Katta durup kalkarken sarsıntı ile duran ve hareket eden, duruşlarda kat seviyesinden aşağıda veya yukarıda kalan. Yani yapması gerekenlerin tam aksisini yaparak işinizi zorlaştıran. Bu sebeple Hastane asansörlerinde Frekans Ayarlı Hız Kontrol Sistemi ve Acil Kata Getirme sistemi kullanmak kaçınılmazdır. Frekans Ayarlı Hız Kontrol sistemi sayesinde konforunuz ve duruş hassasiyetiniz (± 3 mm) garanti altındadır.

8

www.uzayasansor.com





Think about a lift working without **PRECISION**, shaking while moving and stopping at the floors, staying above or below the floor level at stops, in other words doing the exact opposite of what it should do. For this reason, the use of Frequency Adjusted Speed Control System and Emergency Floor Designation system is inevitable at Hospital Lifts. By means of Frequency Adjusted Speed Control System your comfort and stopping precision (± 3 mm) is guaranteed.



GÜÇ 'lü bir asansör aynı zamanda estetik ve güvenli de yapılabilir. Taşıyacağınız yükün asansörün yan duvarlarına ve zeminine zarar vermemesi için güçlendirilmiş malzemeler ve kolayca değıştirilebilen aksamlarla görünümün uzun yıllarca ilk günkü gibi kalacağı güvence altındadır.





A POWERFUL lift can be both safe and esthetic. By means of reinforced equipment and easily replaceable parts the load to be carried would not damage the floor and side walls of the lift and the appearance would remain the same for many years like the first day is guaranteed.





BÜYÜKLÜK araç asansörlerinde tasarımın önemli bir parçasıdır. Küçük ve dar bir alana aracınızı park etmeye çalışırken yaşadığınız stresi araç asansörlerinde de yaşamamanızı istemeyiz. Ayrıca uzaktan kumanda modülü, Otomatik Kat ve Kabin kapıları sayesinde aracınızdan inmenize hiç gerek kalmamaktadır.

12

www.uzayasansor.com



SIZE is an important part of the design of vehicle lifts. We don't want you to experience the same stress while you are trying to park your car to a small and narrow area in a vehicle lift. In addition to that, with the help of the remote control module and Automatic Floor and Cabin doors, you do not need to get out of your car.



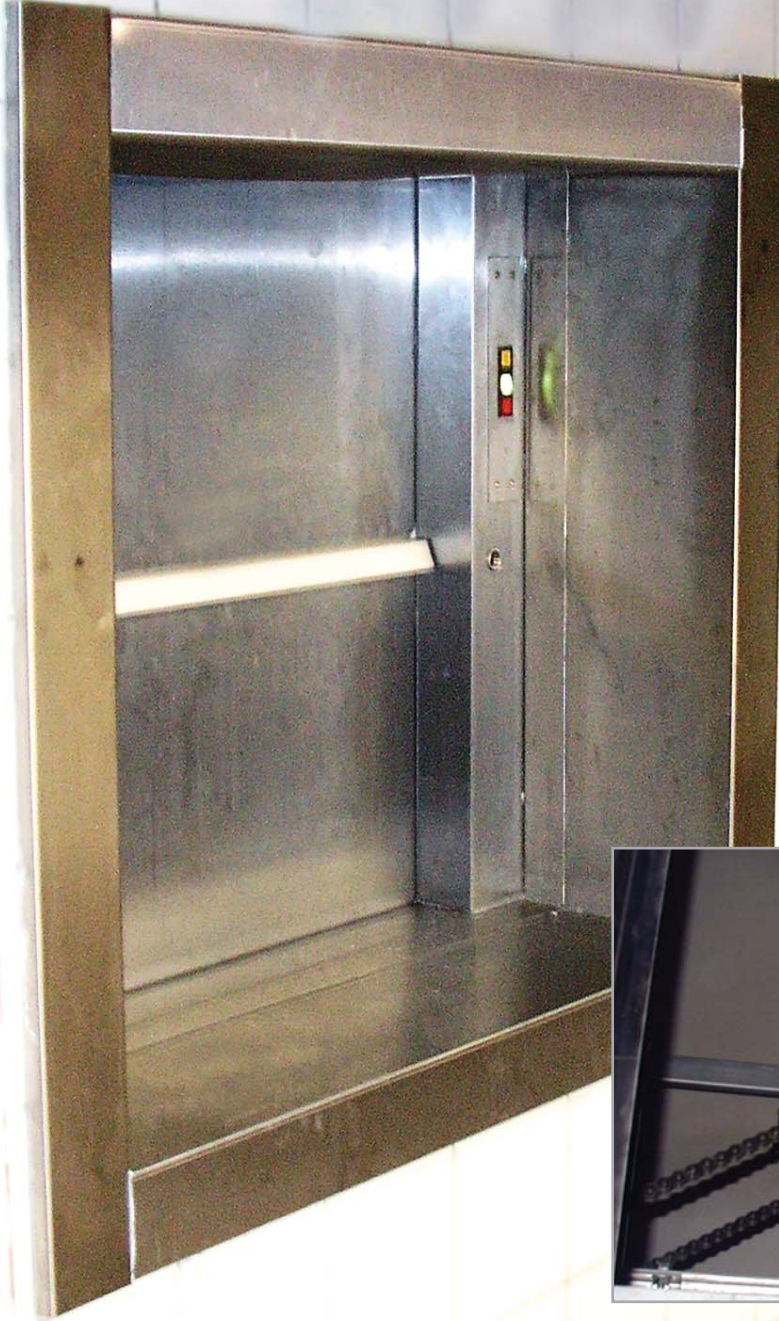

ÇALIŞKAN olmayan bir servis asansörü işinizi zorlaştırmakla kalmaz işinizi yapmanızı da engeller. İster restoran ister hastane olsun hijyenik, sağlam ve özel isteklerinize uygun malzemelerle, uygun çözümler üretilebilir.

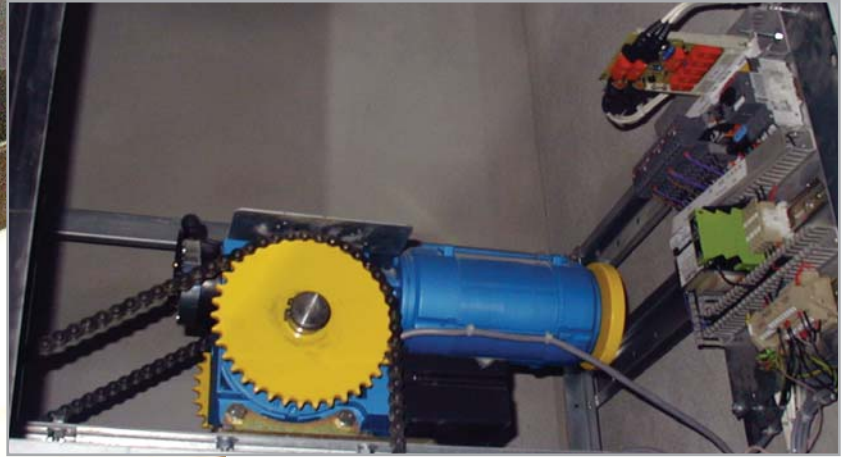

A service lift which is not **HARDWORKING** would not only make your business harder but also create a barricade against your work. Convenient solutions can be created either for a restaurant or a hospital with the suitable hygienic and durable equipment for your specific needs.





6 kata ve 1,00 m/s hıza kadar özellikle ağır yüklerin güvenle kaldırılmasında yaygın olarak kullanılır. Bir tankın içerisindeki yağın elektrik motoru vasıtasıyla piston içerisine gönderilmesi prensibi ile kabin hareket ettirilir. Harekatin kontrollü ve güvenli olmasını ise sistemde kullanılan valfler sağlar.



It is commonly used especially carrying large loads safely up to the 6 floors with the speed of up to 1,00m/sec. Car is moved by sending the oil to the inside of the piston by means of an electric motor. Safe and controlled movement is maintained by the valves used in the system.



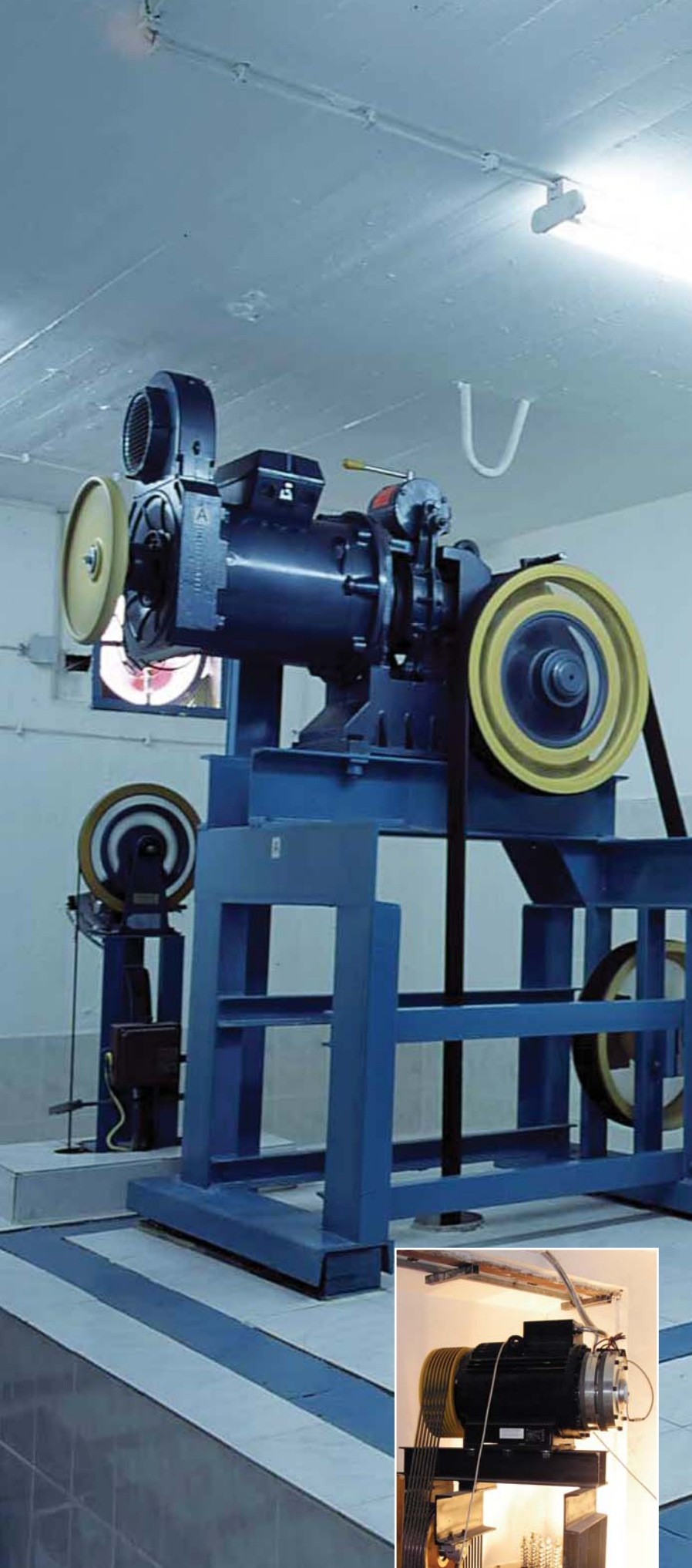

Dişli , dişsiz ve makine dairesiz olmak üzere üç ana gruba ayrılır. Dişli makineler genellikle 75 m yükseklik ve 1,60m/s ye kadar olan hızlar için kullanılır. Dişsiz makineler daha yüksek seyir mesafeli ve daha hızlı asansörlerde kullanılır. Makine dairesinin mimari açıdan problem teşkil ettiği ve istenmediği durumlarda ise çözüm önerimiz Makine dairesiz asansörlerdir.



Can be divided into three main groups as; Geared Traction, Gearless Traction and Machine-Roomless. Geared Traction Lifts usually used for the heights up to 75m and the speeds up to 1,60m/sec. Gearless Traction Lifts are used for faster lifts installed in higher structures. We recommend Machine Roomless Lifts if there is an architectural Machine Room problem or a Machine Room is not wanted.



PANELLER : ELEKTROSTATİK TOZ BOYA RAL 7032
GİRİŞ YANLARI : ELEKTROSTATİK TOZ BOYA
PROFİLLER : ELEKTROSTATİK TOZ BOYA
TUTAMAK : PASLANMAZ ÇELİK 150 mm
AYNA : FLOTAL
TAVAN : ELEKTROSTATİK TOZ BOYA RAL 7032
AYDINLATMA : FLORESAN
SÜPÜRGELİK : PASLANMAZ ÇELİK SATİNE
ZEMİN : PVC SİYAH NOKTALI



WALL PANELLES : ELEKTROSTATIC POWDER PAINT
ENTRANCE SIDES : ELEKTROSTATIC POWDER PAINT
PROFILES : ELEKTROSTATIC POWDER PAINT
HAND RAILS : BRUSHED STAINLESS STEEL 150 mm
MIRROR : FLOAT MIRROR
CEILING : ELEKTROSTATIC POWDER PAINT
LIGHTING : FLUORESCENT
KICK PLATE : BRUSHED STAINLESS STEEL
FLOOR : PVC BLACK DOTTED

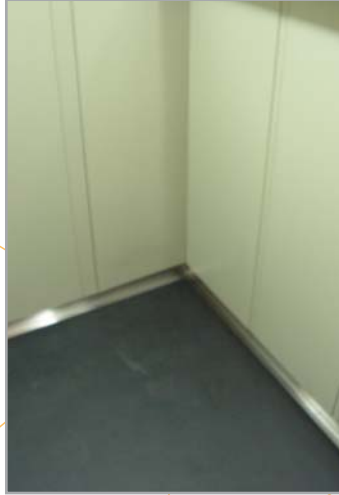

PANELLER : LAMİNAT PVC RAL9006 GÜMÜŞ
GİRİŞ YANLARI : LAMİNAT PVC RAL9006 GÜMÜŞ
PROFİLLER : PASLANMAZ ÇELİK SATİNE
TUTAMAK : PASLANMAZ ÇELİK 25 mm
AYNA : FLOTAL
TAVAN : PASLANMAZ ÇELİK SATİNE
AYDINLATMA : FLORESAN
SÜPÜRGELİK : PASLANMAZ ÇELİK SATİNE
ZEMİN : LİNOLYUM ANTRASİT 86484



WALL PANELLES : LAMİNATE PVC RAL 9006 SILVER
ENTRANCE SIDES : LAMİNATE PVC RAL 9006 SILVER
PROFILES : BRUSHED STAINLESS STEEL
HAND RAILS : BRUSHED STAINLESS STEEL 25 mm
MIRROR : FLOAT MIRROR
CEILING : BRUSHED STAINLESS STEEL
LIGHTING : FLUORESCENT
KICK PLATE : BRUSHED STAINLESS STEEL
FLOOR : LİNOLYUM ANTRASİT 86484





PANELLER : LAMİNAT PVC MAHOGANY
 GİRİŞ YANLARI : PASLANMAZ ÇELİK SATİNE
 PROFİLLER : PASLANMAZ ÇELİK SATİNE
 TUTAMAK : PASLANMAZ ÇELİK 25 mm
 AYNNA : FLOTAL
 TAVAN : PASLANMAZ ÇELİK SATİNE
 AYDINLATMA : FLORESAN
 SÜPÜRGELİK : PASLANMAZ ÇELİK SATİNE
 ZEMİN : GRANİT SERAMİK KOYU GRİ

WALL PANNELLES : LAMINATE PVC MAHOGANY
 ENTRANCE SIDES : BRUSHED STAINLESS STEEL
 PROFILES : BRUSHED STAINLESS STEE
 HAND RAILS : BRUSHED STAINLESS STEEL 25 mm
 MIRROR : FLOAT MIRROR
 CEILING : BRUSHED STAINLESS STEE
 LIGHTING : FLUORESCENT
 KICK PLATE : BRUSHED STAINLESS STEEL
 FLOOR : GRANITE CERAMIC DARK GREY



PANELLER : LAMİNAT PVC KIRAZ
 GİRİŞ YANLARI : PASLANMAZ ÇELİK SATİNE
 PROFİLLER : PASLANMAZ ÇELİK SATİNE
 TUTAMAK : PASLANMAZ ÇELİK 25 mm
 AYNNA : FLOTAL
 TAVAN : PASLANMAZ ÇELİK SATİNE
 AYDINLATMA : FLORESAN
 SÜPÜRGELİK : PASLANMAZ ÇELİK SATİNE
 ZEMİN : GRANİT SERAMİK KOYU GRİ

WALL PANNELLES : LAMINATE PVC CHERRY
 ENTRANCE SIDES : BRUSHED STAINLESS STEEL
 PROFILES : BRUSHED STAINLESS STEEL
 HAND RAILS : BRUSHED STAINLESS STEEL 25 mm
 MIRROR : FLOAT MIRROR
 CEILING : BRUSHED STAINLESS STEEL
 LIGHTING : FLUORESCENT
 KICK PLATE : BRUSHED STAINLESS STEEL
 FLOOR : GRANITE CERAMIC DARK GREY



PANELLER : LAMİNAT HPL GÜL
GİRİŞ YANLARI : PASLANMAZ ÇELİK SATİNE
PROFİLLER : PASLANMAZ ÇELİK SATİNE
TUTAMAK : PASLANMAZ ÇELİK 25 mm
AYNA : FLOTAL BRONZ
TAVAN : PASLANMAZ ÇELİK SATİNE
AYDINLATMA : SPOT MİNİ HALOGEN KROME
SÜPÜRGELİK : PASLANMAZ ÇELİK SATİNE
ZEMİN : GRANİT NATUREL ROSSO BALMORAL



WALL PANNELLES : LAMİNATE HPL ROSE
ENTRANCE SIDES : BRUSHED STAINLESS STEEL
PROFILES : BRUSHED STAINLESS STEEL
HAND RAILS : BRUSHED STAINLESS STEEL 25 mm
MIRROR : FLOAT MIRROR BRONZE
CEILING : BRUSHED STAINLESS STEEL
LIGHTING : MINI HALOGEN CHROME PLATED
KICK PLATE : BRUSHED STAINLESS STEEL
FLOOR : GRANITE NATURAL ROSSO BALMORAL



PANELLER : LAMİNAT HPL AKAĞAÇ
GİRİŞ YANLARI : PASLANMAZ ÇELİK SATİNE
PROFİLLER : PASLANMAZ ÇELİK SATİNE
TUTAMAK : PASLANMAZ ÇELİK 25 mm
AYNA : FLOTAL
TAVAN : PASLANMAZ ÇELİK SATİNE
AYDINLATMA : FLORESAN
SÜPÜRGELİK : PASLANMAZ ÇELİK SATİNE
ZEMİN : GRANİT NATUREL LABRADOR €PEARL



WALL PANNELLES : LAMİNATE HPL MAPLE
ENTRANCE SIDES : BRUSHED STAINLESS STEEL
PROFILES : BRUSHED STAINLESS STEEL
HAND RAILS : BRUSHED STAINLESS STEEL 25 mm
MIRROR : FLOAT MIRROR
CEILING : BRUSHED STAINLESS STEEL
LIGHTING : FLUORESCENT
KICK PLATE : BRUSHED STAINLESS STEEL
FLOOR : GRANITE NATURAL LABRADOR €PEARL





PANELLER : LAMİNAT HPL METALİK ÇİZGİLİ
 GİRİŞ YANLARI : PASLANMAZ ÇELİK SATİNE
 PROFİLLER : PASLANMAZ ÇELİK SATİNE
 TUTAMAK : PASLANMAZ ÇELİK 25 mm
 AYNA : FLOTAL
 TAVAN : PASLANMAZ ÇELİK SATİNE
 AYDINLATMA : FLORESAN
 SÜPÜRGE LİK : PASLANMAZ ÇELİK SATİNE
 ZEMİN : GRANİT NATUREL LABRADOR E.PEARL



WALL PANELLES : LAMINATE HPL METALIC LINE
 ENTRANCE SIDES : BRUSHED STAINLESS STEEL
 PROFILES : BRUSHED STAINLESS STEEL
 HAND RAILS : BRUSHED STAINLESS STEEL 25 mm
 MIRROR : FLOAT MIRROR
 CEILING : BRUSHED STAINLESS STEEL
 LIGHTING : FLUORESCENT
 KICK PLATE : BRUSHED STAINLESS STEEL
 FLOOR : GRANITE NATUREL LABRADOR E.PEARL



PANELLER : LAMİNE CAM OPAK MAVİ
 GİRİŞ YANLARI : PASLANMAZ ÇELİK SATİNE
 PROFİLLER : PASLANMAZ ÇELİK SATİNE
 TUTAMAK : PASLANMAZ ÇELİK 38 mm
 AYNA : FLOTAL
 TAVAN : PASLANMAZ ÇELİK SATİNE
 AYDINLATMA : FLORESAN
 SÜPÜRGE LİK : PASLANMAZ ÇELİK SATİNE
 ZEMİN : GRANİT NATUREL LABRADOR E.PEARL



WALL PANELLES : LAMINATED GLASS OPAQUE BLUE
 ENTRANCE SIDES : BRUSHED STAINLESS STEEL
 PROFILES : BRUSHED STAINLESS STEEL
 HAND RAILS : BRUSHED STAINLESS STEEL 38 mm
 MIRROR : FLOAT MIRROR
 CEILING : BRUSHED STAINLESS STEEL
 LIGHTING : FLUORESCENT
 KICK PLATE : BRUSHED STAINLESS STEEL
 FLOOR : GRANITE NATUREL LABRADOR E.PEARL



Asansörle iletişim kurmanızın bir çok yolu var ancak en kolayı butonları kullanarak nereye gitmek istediğinizi bildirmek ve göstergelere bakarak ta o anda nerede olduğunuzu anlamaktır. Buton ve göstergelerdeki çeşitlilik nerdeyse sınırsızdır.





There are many different ways to communicate with the lift. However; the easiest way is using the control panel to inform where you want to go and by looking at the control panel to understand where are you at that moment. The variety of the control panels and buttons has almost no boundaries.





CERTIFICATE

Certificate no: 253

The documentation and implementation of the Quality System of
Uzay Asansör Sanayi
Ticaret ve Pazarlama Limited Şirketi.
Ziya Gokalp Caddesi No:22/32
06420 Kızılay
Ankara - Turkey

comply with the requirements of;

TS-EN-ISO 9001:2000

Scope:

design, import, export, installation, repair, modernization, maintenance and services of lifts and production of doors,cars,car frames,counter weight frames,guide rail connectors for Lifts.

This certificate is issued on the basis of the following report:

LI. 253.A

File no: 06420-22

This certificate was issued on June 24th 2004
and is valid till June 24th 2007

Firmamız müşteri memnuniyeti için sürekli iyileştirmenin gerekliliğine ve toplam kalite yönetiminin mükemmelliğe ulaşmada temel şart olduğuna inanmaktadır. Bu doğrultuda ISO 9001 Kalite Sistemini bünyesinde kurmuş ve belgelendirmiştir. Firmamız ayrıca hizmet verdiği sektörde üretim, ticaret, çalışanlar ve sosyal güvenlikle ilgili yasalardan gerekli gördüğü tüm resmi sertifikalara sahiptir.



For the customer satisfaction, our company believes that Total Quality Management is the fundamental condition for continuous development. In this direction ISO 9001 Quality System is formed and certified in its body. Our Company has all the required official certificates by law in its sector such as production, commercial, employees and social security.



LIFTINSTITUUT B.V.
MEERPLEIN 381
AMSTERDAM
NETHERLANDS

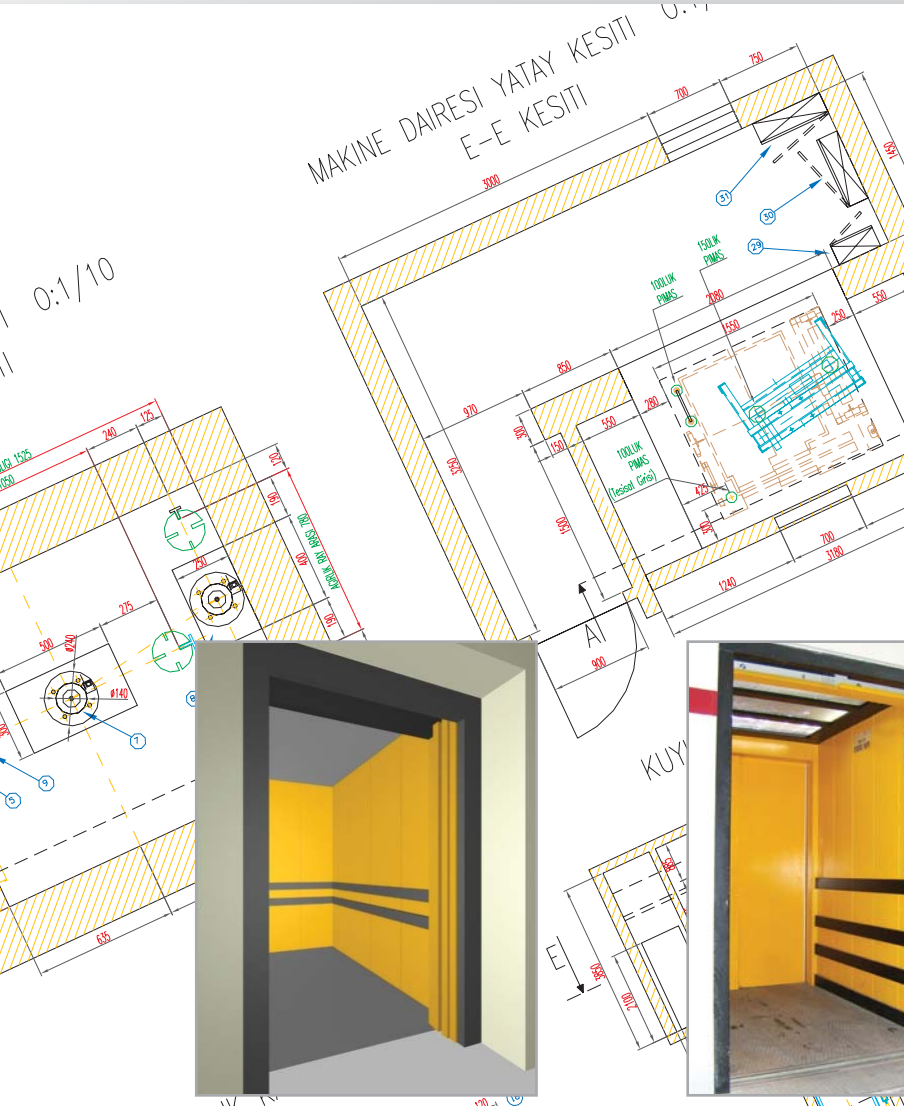

Projelendirme için gereken olan yapıya ait tüm bilgiler, müşterinin istekleri ve dikkat çektiği hususlar firmanın kalifiye elemanları tarafından ilgili formlara not edilerek projelendirmeyi yapacak olan ilgili mühendislere ulaştırılır. Çizimler ve hesaplamalar, özellikle bu amaçlar için tasarlanmış firma adına lisanslı bilgisayar programları kullanılarak yine yetkili mühendisler tarafından yapılır.

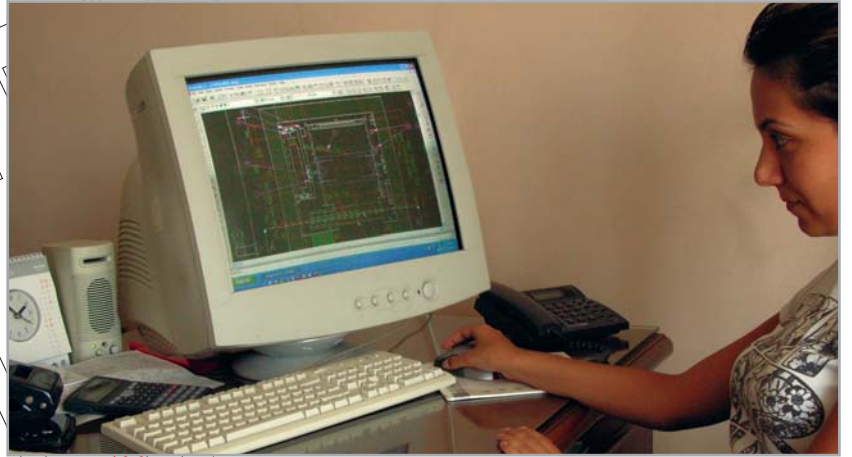
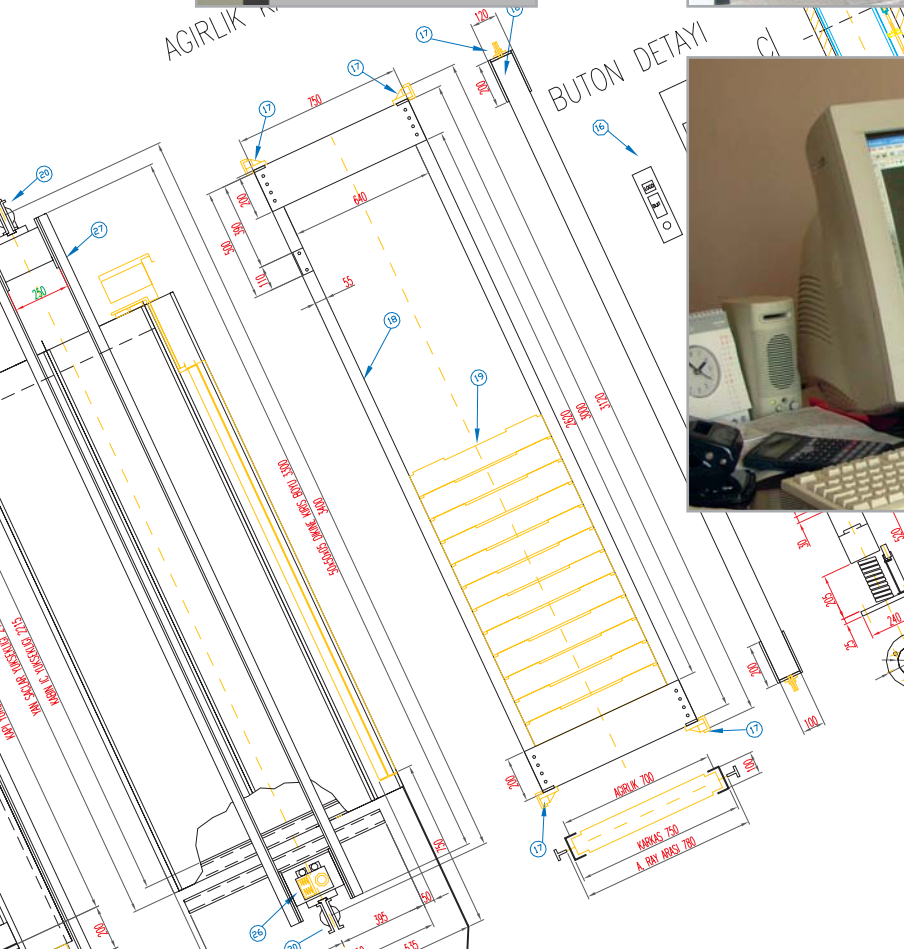

The measurement, of the lift that is going to be built is taken on location by the company designers and engineers. Qualified staff notes down and forwards the engineers relevant information necessary for the design of the elevator, and the demands and the aspects which are pointed out by the consumer. Drawings and calculations are carried out by qualified engineers using especially designed licensed software on behalf of the Company.



Asansörler kullanıldıkları mekana göre kimi zaman günde 24 saat kesintisiz hizmet vermek zorunda olan araçlardır. Bu kadar yoğun bir tempo, mutlaktır ki asansörün binlerce bileşeninden birkaç tanesinde zaman içinde aksamalara yol açacaktır. Bu zamansız aksamaların önüne geçebilmek için yapılması gereken çok basit bir işlem vardır. Periyodik bakım.



Elevators, depending on the traffic of the buildings they are mounted, are sometimes in use 24 hours a day. Such a dense tempo will certainly bring out malfunctioning in some pieces of those machines in time. There is a simple process to prevent those kinds of defects before they appear. Periodical maintenance.



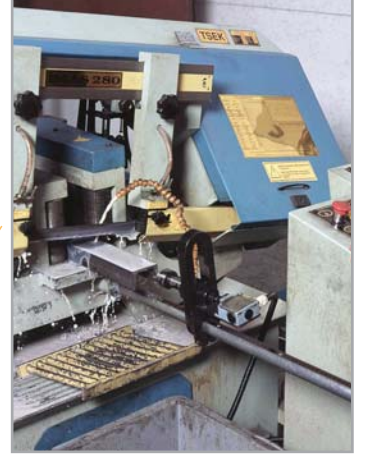

Asansörün montajı sırasında gerekecek bir çok metal imalat firmanın kendi fabrikasında kendi olanaklarıyla yapılmaktadır. Tüm işlemler ilgili normlara uygun bir şekilde yetkili mühendisler ve belgeli ustaların kontrolünde yürütülür.



Uzay Asansör Ltd. produces a great percentage of the metal-ware it installs in their factory with its own resources. All process is carried out under the observation of qualified engineers and skilled workmen by the required norms.



KONUT ASANSÖRLERİ İÇİN KABIN KAPI VE KUYU ÖLÇÜLERİ

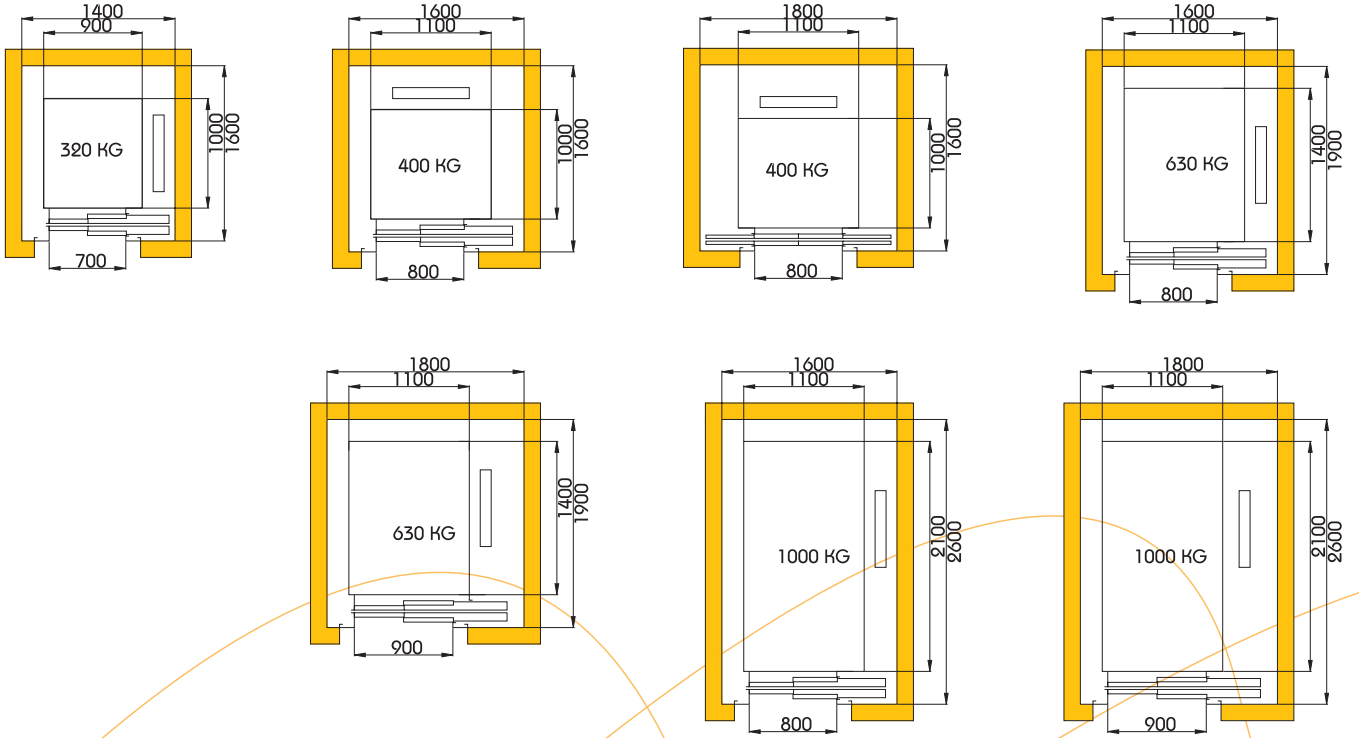

KONUT DIŐI YAPI ASANSÖRLERİ İÇİN KABIN KAPI VE KUYU ÖLÇÜLERİ

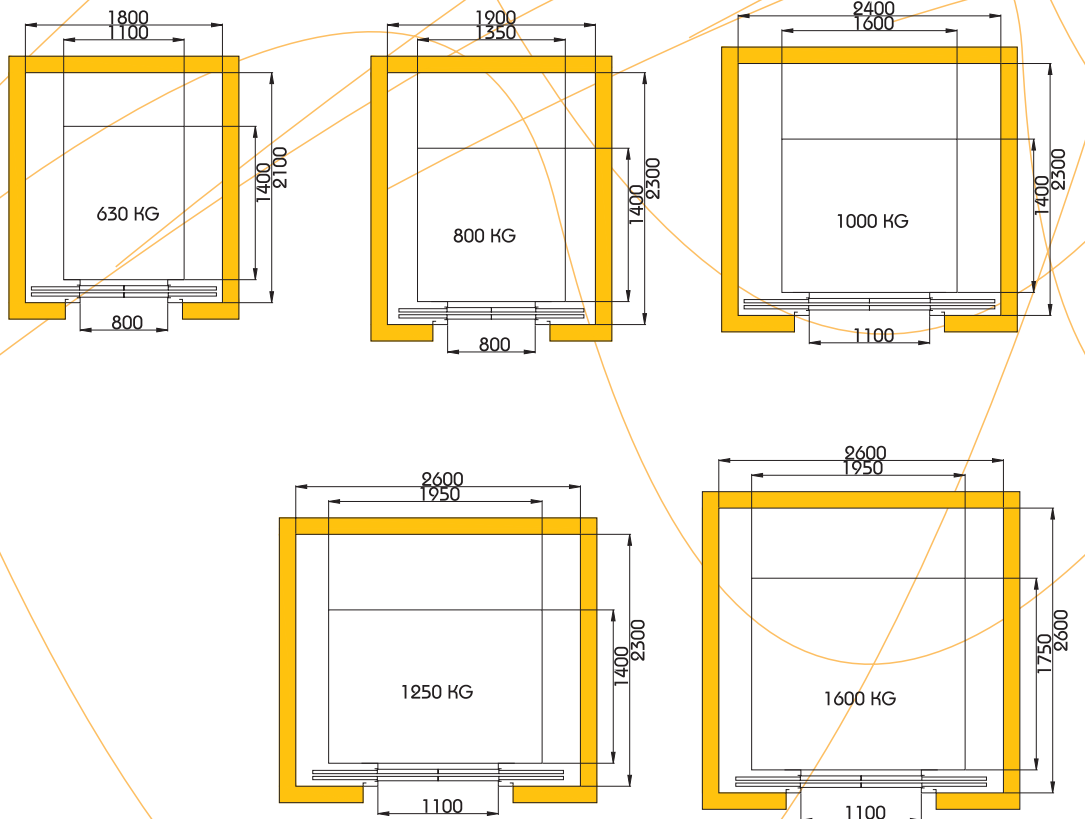

Makine Daireleri, Kuyu Alt ve Üst Boşlukları için Firmamızla Temasa Geçiniz.

HASTANE ASANSÖRLERİ İÇİN KABIN KAPI VE KUYU ÖLÇÜLERİ

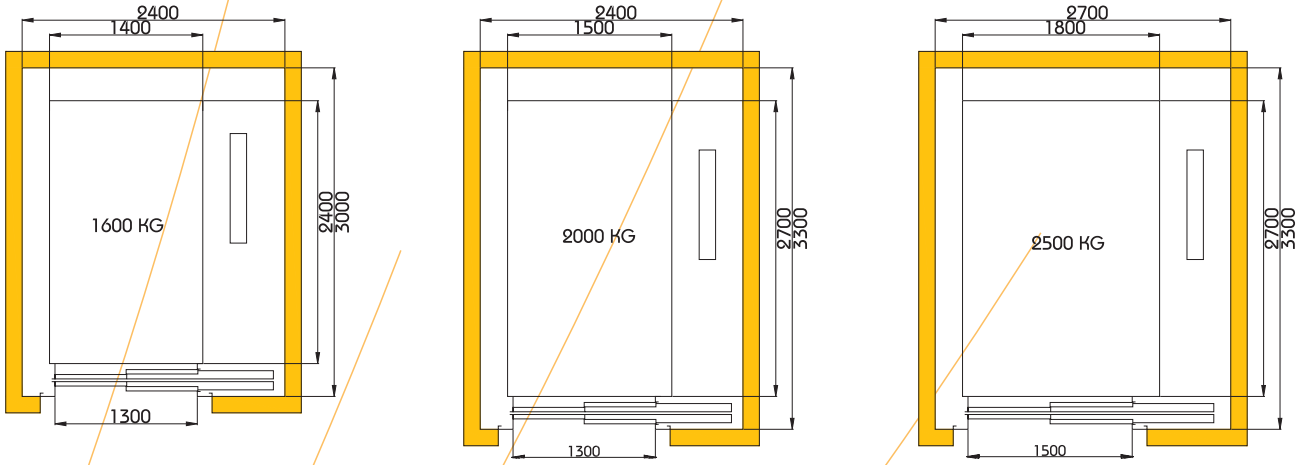

YÜK ASANSÖRLERİ İÇİN KABIN KAPI VE KUYU ÖLÇÜLERİ

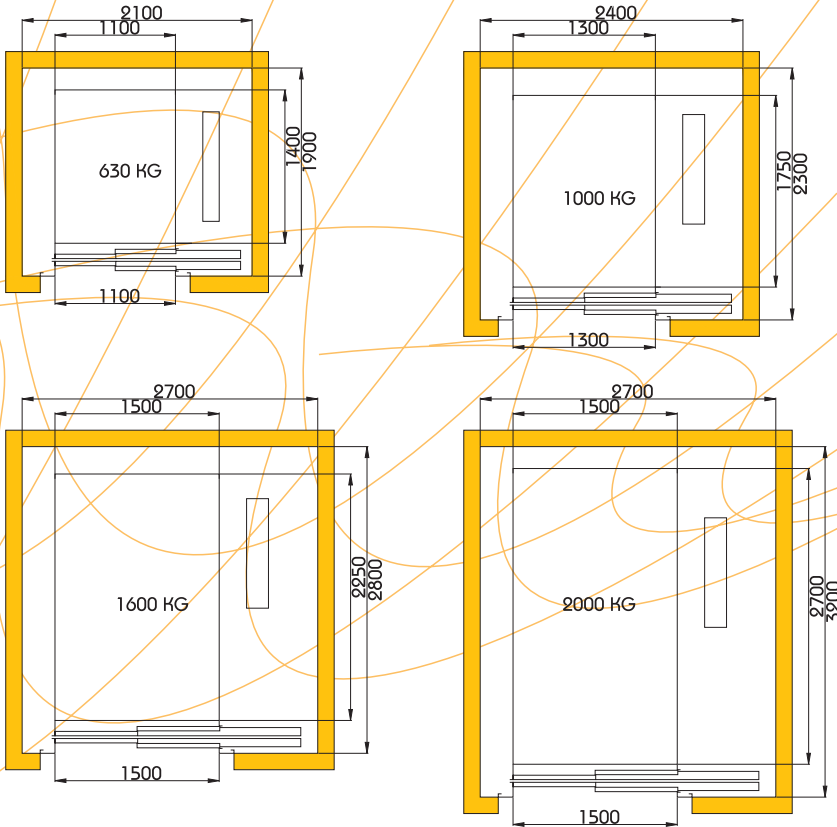

SEVİS ASANSÖRLERİ İÇİN KABIN KAPI VE KUYU ÖLÇÜLERİ

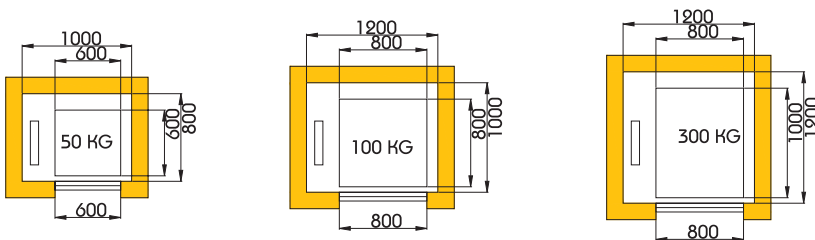



Peugeot Göröl



Serdar Plastik



Hidro Kontrol



Düzce Atatürk Devlet Hastanesi



İstikbal Showroom



Doğulu Holding



Ssk Genel Müdürlüğü



Uzay Asansör Fabrika



Ankara Sanaî Odası



Oymapınar HES Manavgat



Ankara Numune Hastanesi



Mithatpaşa Vergi Dairesi



Hacı Bektaş Vakfı



Millenium Outlet Park



İller Bankası Genel Müdürlüğü



UZAY

ASANSÖR SANAYİ TİCARET ve PAZARLAMA LİMİTED ŞİRKETİ

Ziya Gökalp Cad. No:22/32 Kızılay 06420 Ankara Türkiye

Tel : +90 312 431 31 41 Faks : +90 312 434 46 47

www.uzayasansor.com info@uzayasansor.com